

## EN User Manual | Coffee Machine

**NKC8N7T**

**NKC8N7B**

**TC8NK7T**

**TC8NK7B**

**CK7100T**

**CK7100B**

**PSC8000T**

**PSC8000B**



**Welcome to AEG! Thank you for choosing one of our products.**



For user tips, troubleshooting information, support and repairs, visit:  
[aeg.com/support](http://aeg.com/support)

Subject to change without notice.

## CONTENTS

1. SAFETY INFORMATION .....	2
2. SAFETY INSTRUCTIONS .....	4
3. PRODUCT DESCRIPTION .....	6
4. CONTROL PANEL .....	7
5. BEFORE FIRST USE .....	8
6. DAILY USE .....	8
7. MAINTENANCE AND CLEANING .....	11
8. DESCALING .....	12
9. SETTING WATER HARDNESS .....	12
10. WATER SOFTENER FILTER .....	12
11. TECHNICAL DATA .....	13
12. ENVIRONMENT CONCERNS .....	13
13. ENERGY EFFICIENCY .....	13
14. DISPLAYED MESSAGES .....	13
15. TROUBLESHOOTING .....	15

### 1. SAFETY INFORMATION

Before the installation and use of the machine, carefully read the supplied instructions. The manufacturer is not responsible if an incorrect installation and use causes injuries and damages. Always keep the instructions with the machine for future reference.

#### 1.1 Safety of children and vulnerable persons

- The machine is not intended for use by persons with reduced physical, sensory or mental capabilities, or with insufficient experience and knowledge, unless they are properly supervised or have been instructed on safe use of the appliance by a person responsible for their safety.
- Children should be supervised to ensure that they do not play with the machine.
- For European markets only:
- This machine can be used by children aged 8 years and over provided they are supervised or have been instructed on safe

use of the machine and are aware of the dangers involved. Cleaning and user maintenance shall not be made by children unless they are older than 8 and supervised. Keep the machine and its cord out of the reach of children aged less than 8 years.

- Children must not play with the machine.

## **1.2 General Safety**

- Intended use: this machine is designed and developed to prepare milk-, coffee- and hot water-based beverages. Any other use is considered improper and thus dangerous. The manufacturer is not liable for damage deriving from improper use of the machine.
- The surface of the heating element remains hot after use and the outside of the machine may retain the heat for several minutes depending on use.
- Clean all the components thoroughly, taking particular care with parts in contact with the coffee and milk.
- Cleaning and user maintenance shall not be made by children without supervision.
- Never submerge the machine into water.
- CAUTION: To prevent damage to the machine, do not use alkaline cleaning agents when cleaning, use a soft cloth and a mild detergent.
- This machine is for household use only. It is not intended to be used in: staff kitchen areas in shops, offices and other working environments; farm houses; by clients in hotels, motels and other residential type environments; bed and breakfast type environments.
- If the plug or power cable is damaged, it must be replaced by customer services only to avoid all risk.
- Machines with removable cord: avoid splashes of water on the power cord connector or socket at the back of the appliance.
- WARNING: Models with glass surfaces: do not use the ma-

chine if the surface is cracked.

- For European markets only:
- Machines can be used by persons with reduced physical, sensory or mental capabilities or lack of experience and knowledge only if they are supervised or have been instructed on safe use of the machine and understand the hazards involved.
- Always disconnect the machine when not in use and before cleaning.



Surfaces marked with this symbol become hot during use (the symbol is present in certain models only).

## 2. SAFETY INSTRUCTIONS

### 2.1 Installation



#### **WARNING!**

This machine must be installed only by qualified personnel.

Read these instructions carefully before using the machine.

- Keep these instructions
- Failure to respect these instructions may result in burns or damage to the machine.
- Never touch the machine with damp hands.
- Never touch the plug with damp hands.
- Make sure the socket used is freely accessible at all times, enabling the machine to be unplugged when necessary.
- Unplug directly from the plug only.
- Never pull the power cable as you could damage it.
- To disconnect the machine completely, place the main switch (A1) on the side of the machine in the 0 position.
- If the machine is faulty, do not attempt to repair.
- Turn it off using the main switch (A1), unplug from the mains socket and contact Customer Services.
- Keep all the packaging (plastic bags) away from children.
- Install the machine according to the instructions in the manual to ensure there is no spillage when it is removed from its frame.

- The machine is equipped with a cooling fan. This comes on whenever coffee, steam or hot water is delivered. After several minutes, the fan goes off automatically.

#### **Suitable cable types for installation or replacement:**

H05 VV-F, H05 V2V2-F (T90)

For the cable size, see the total power reported on the nameplate. Another table can also be consulted:

Total power (W)	Cable size (mm <sup>2</sup> )
maximum 2300	3 x 1

### 2.2 Electrical connection



#### **WARNING!**

Risk of fire and electric shocks.

- Check that the supply voltage corresponds to the value reported on the nameplate on the side of the machine. Connect the machine to a properly installed and earthed power socket only with a minimum current of 10A. If the power socket does not match the plug on the machine, have the socket replaced with a suitable type by a qualified professional.

To comply with safety directives, an omnipo- lar switch with a minimum contact distance of 3 mm must be installed.

Do not use multiple sockets or extensions.

- The power supply must include safety disconnect switches in compliance with the installation regulations in force in the country of installation.

## 2.3 Using the machine



### **WARNING!**

Risk of injury, burns, electric shock or explosion.

- During use, the machine produces hot water and steam.  
Avoid contact with splashes of water or hot steam. Use knobs and handles.
- Do not grab the coffee machine when it is out of its frame.  
Do not place containers with flammable or corrosive liquids or materials on the machine, either when extracted or inserted. Place the accessories required to make the coffee (the measure for example) in the special holder. Do not rest large objects which could obstruct movement or unstable objects on the machine.  
Do not allow children and animals to stop or loiter near the machine when it has been removed from its frame.  
Do not use the machine while out of its frame. Do not leave the machine out of its frame unless strictly necessary.
- Do not use the machine if it has been removed from its frame. Check that the machine is switched off before removing it. The only exception is adjusting the coffee mill which must be done with the machine out (see the section "Adjusting the coffee mill").
- Use only original or manufacturer-recommended accessories and spare parts.
- This machine is designed and developed to prepare coffee and hot drinks. All other use is considered improper. This machine is not suitable for commercial use.  
The manufacturer is not liable for damage deriving from improper use of the machine. This machine can be installed over a built-in oven if the latter is fitted with a cooling fan at the rear (maximum microwave power: 3 kW).

- The manufacturer is not liable for damage deriving from failure to respect these instructions.

## 2.4 Maintenance and cleaning



### **WARNING!**

Risk of injury, fire or machine damage.

- Always switch off the machine before maintenance.
- Clean the machine with a soft, damp cloth. Use only neutral detergents. Do not use abrasive products, abrasive cleaning pads, solvents or metal objects.
- The appliance must not be immersed in the water (EN/IEC 60335-2-15).

## 2.5 Assistance

- For machine repairs, contact the Authorised Service Centre.
- Use only original spare parts.

## 2.6 Disposal



### **WARNING!**

Risk of injury or suffocation.

- Disconnect the machine from the mains.
- Remove the network cable near the appliance and dispose of it properly.

## 3. PRODUCT DESCRIPTION

### 3.1 General overview

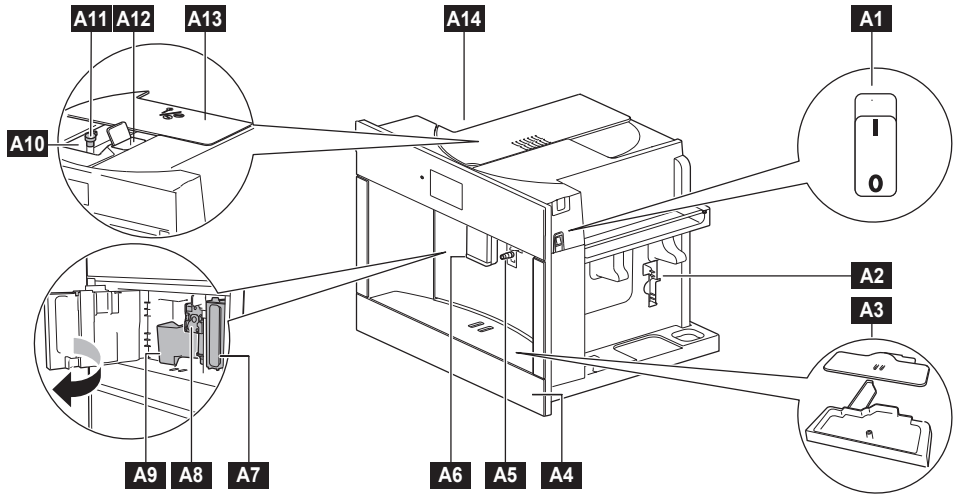

- A1** Main switch
- A2** Accessories compartment (left/right)
- A3** Drip tray
- A4** Drip tray cover
- A5** Hot water/steam connection nozzle
- A6** Coffee spout (adjustable height)
- A7** Removable water tank
- A8** Brewing unit

- A9** Used coffee grounds container
- A10** Coffee beans container
- A11** Grind size adjustment dial
- A12** Ground coffee funnel
- A13** Swivel lid
- A14** Cup warmer (left)

Average temperature 35°C with cup warmer function enabled and automatic power-off set to at least 2 hours

### 3.2 Accessories

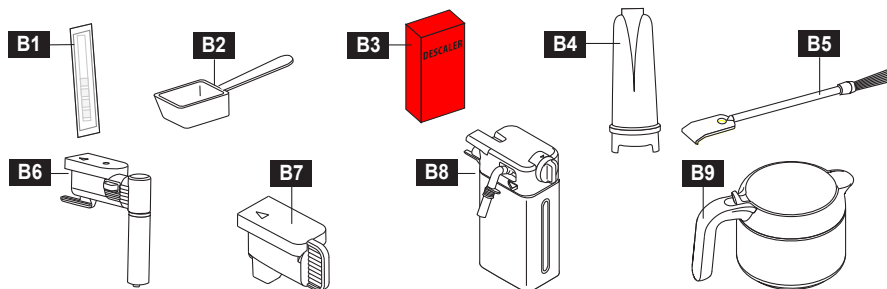

- B1** "Total Hardness Test" indicator paper
- B2** Ground coffee scoop
- B3** Descaler \*
- B4** Water softener filter \*
- B5** Cleaning brush

- B6** Hot water/steam spout
- B7** Connection nozzle cover
- B8** Milk container
- B9** Coffee jug \*

(\*) Only available for certain models

## 4. CONTROL PANEL

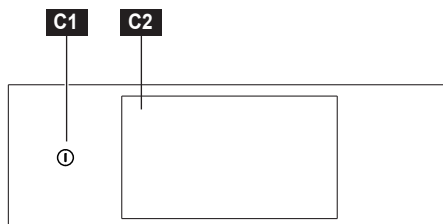

Keys	Function	Description
<b>C1</b> ①	ON/STAND-BY	To activate and deactivate the machine. Hold this key pressed (3 sec) to switch off the heating elements.
<b>C2</b>	DISPLAY	Shows the current coffee machine settings. Tap to turn on the display when in "Ready to use" mode.

 <b>Press</b>	 <b>Move</b>	 <b>Hold pressed</b>
Tap the surface with your fingertip.	Slide your fingertip on the surface	Tap the surface for 3 seconds

## 5. BEFORE FIRST USE

### **WARNING!**

See the safety chapters.

#### 1. Clean the machine before first use

 See the "Maintenance and Cleaning" chapter.

#### 2. Connect the machine

Connect the machine to the mains and turn on the main switch. **A1**

#### 3. Setting and rinsing

Follow the instructions on the display.

## 6. DAILY USE

### **WARNING!**

See the safety chapters.

#### IMPORTANT NOTE ON POWER CONSUMPTION

To meet power consumption requirements, the machine is factory-set to stay in Ready to Use mode for 30 minutes.



During this period, the heating elements are on and the machine is ready to use.









In the settings, it is possible to set a shorter or longer time for the "Keep Warm" (Ready to use) function.

When the machine is on and not in Ready to use mode, it runs an automatic preheating and rinse cycle that cannot be interrupted. The machine is ready to use only upon completion of this cycle.

The settings for each beverage can be customised and saved in favourites.

### 6.1 Setting the desired beverage

Keys	Drinks
	<b>Hot Water</b> Hot water for your favourite teas and infusions
	<b>Ristretto</b> A short shot of Espresso made with half the water of a standard espresso. Perfect for those who want an even bolder espresso flavor
	<b>Espresso</b> The Italian classic shot of coffee. Full flavoured, concentrated, served in small cups

Keys	Drinks
	<b>Espresso Lungo</b> A longer shot of Espresso. Still full-flavoured and served in small cups
	<b>Café Lungo</b> A shot of Espresso that is more than twice the size of a standard shot. Made with a larger amount of ground coffee and a deep pre-infusion for extra aroma
	<b>Long Coffee</b> A coffee that combines filter-strength flavour and crema. It is made with a longer brewing time than a standard Espresso. A sharper flavour than an Americano
	<b>Americano</b> An Americano combines the flavour of an Espresso shot with additional water to offer the strength of filter coffee. Perfect for those who want a full mug of coffee
	<b>Espresso Macchiato</b> A boldly flavoured drink with a single shot of Espresso, slightly softened with a small dash of steamed milk
	<b>Macchiato</b> A long coffee made with an extended brewing time. Filter-strength but with a sharper flavour than an Americano, slightly softened by a dash of steamed milk
	<b>Cappuccino</b> A medium-sized coffee made with a single shot of Espresso, hot milk, and a layer of rich, dense foam on top
	<b>Cappuccino Plus</b> Larger than a standard cappuccino, with a double+ shot of Espresso, hot milk, and a layer of rich, dense foam on top
	<b>Latte Macchiato</b> A single Espresso shot mixed with steamed milk to create a medium-sized cup of coffee, with a medium level of foam on top

Keys	Drinks
	<b>Flat White</b> A double Ristretto shot giving a bold flavour, combined with steamed milk and a velvety foam layer on top
	<b>Caffe Latte</b> A single Espresso shot mixed with hot milk for a soft, gentle drink. Finished with just a little touch of foam
	<b>Hot Milk</b> Hot milk with the level of foam of your choice
	<b>Steam</b> The steam programme let you steam milk to a perfect consistency for several cups of coffee at the same time. For a denser froth, use refrigerated milk. Always clean the spout after use
	<b>Jug</b> The jug programme is ideal for serving several guests at the same time. It makes up to six cups of your favourite coffee selection

## 6.2 Preparing coffee

### WARNING!

Do not use green, caramelised or candied coffee beans as they could stick to the coffee mill and make it unusable.

- Place a cup (or two cups) under the coffee spouts **A6**.
- Lower the coffee spout into the cup. This makes a creamier coffee;
- Select the desired coffee: Ristretto, Espresso, Espresso Lungo, Cafè Lungo, Long Coffee, Americano.



- For certain drinks, it is possible to customise the aroma, amount of coffee and number of cups.



- Press "START" to start pouring the drinks.

Press the  icon for information on the selected drink

 The drinks can be ordered according to personal preference: press and hold for three seconds the icon of the drink you wish to move. As soon as the icon lifts, drag and drop it in the desired position. To restore the order of the drinks, select "Settings", "Service" and then "Reset drink order".

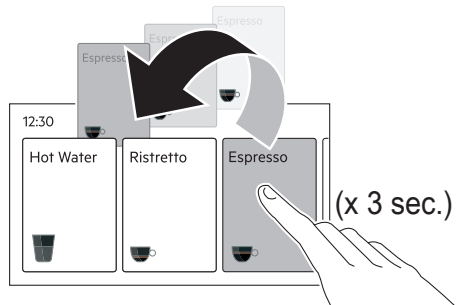

## 6.3 Adjusting the coffee mill

### CAUTION

Select a coffee-based drink with an extra-strong aroma and turn the grind adjustment dial during grinding (grind sound).

#### Dial position

#### Recommended for...

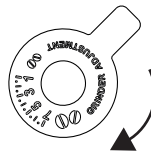

Turn clockwise (high number/coarse grind) for less dense cream.

Turn slowly by 1 click at a time during grinding (grind sound).

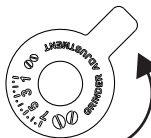

Turn counter-clockwise (lowest number/finest grind) for more dense cream.

Turn slowly by 1 click at a time during grinding (grind sound).

If the message "Ground too fine. Adjust grind level" appears on the display and the coffee is not delivered, turn the dial clockwise by 1 or 2 clicks. It may be necessary to prepare at least 2 drinks to assess the newly made adjustment.

## 6.4 Pre-ground coffee

1. Add a scoop of pre-ground coffee only with the machine switched on.

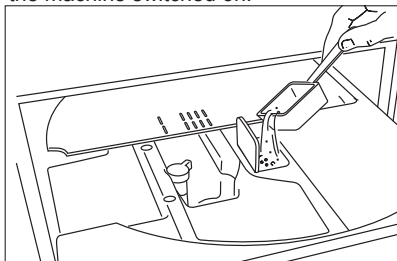

2. Select the desired drink (e.g. Espresso).
3. Press “Aroma”, then “Pre-ground coffee” and press “OK”.
4. Press the “START icon”. Preparation begins.

Not all drinks have the Pre-ground option.

## 6.5 Automatic preparation of milk-based drinks

**i** For ideal frothing, it is recommended to use semi-skimmed milk at a temperature below 5°C.

1. Remove the hot water/steam spout **B6** ;
2. Fill the milk container **B8** with enough milk, without exceeding the MAX level indicated on the container.
3. Insert the milk container **B8** in the steam connection nozzle **A5** until the acoustic signal sounds.
4. Place a cup under the coffee spouts.
5. Select the desired milk-based drink: Espresso Macchiato, Macchiato, Cappuccino, Cappuccino Plus, Latte Macchiato, Flat white, Caffe Latte, Hot Milk.

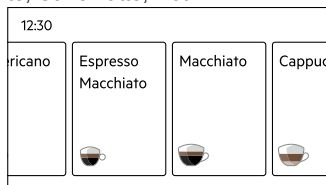

6. Press the “START icon”. Preparation begins.

Turn the froth adjustment dial on the milk container lid to adjust the frothing level:

Dial position	Recommended for...
No froth	Caffe Latte / Hot milk
Min. froth	Latte Macchiato
Max. froth	Cappuccino / Hot Milk (frothed milk)

## 6.6 Preparing milk-based drinks with the steam spout.

1. Insert the steam spout **B6** in the steam connection nozzle **A5** and select the “Steam” function on the display.
2. Press “START” to start delivery.

## 6.7 Automatic start

The “Automatic start” time can be set so that the machine is ready to use at a certain time (for example, the morning) to instantly prepare the coffee. In “Settings”, “Setup” and subsequently “Auto Start”, it is possible to set the preferred time.

To enable this function, the time must already be set correctly.

## 6.8 Ready to use (Keep warm)

The machine can be programmed to stay in Ready to use mode for a period from 15 minutes to 3 hours. In “Settings”, “Setup” and subsequently “Keep warm”, it is possible to set the preferred period of time.

During this period of time, the machine is always ready to use and the heating elements remain switched on.

The default time setting is 30 minutes.

## 7. MAINTENANCE AND CLEANING

### **WARNING!**

See the safety chapters.



### **Cleaning the coffee machine**

To clean the coffee machine, select "Maintenance", "Cleaning Guides" and lastly "Machine Cleaning". Follow the instructions on the display. The following machine parts must be regularly cleaned and left to dry: ground coffee container, drip tray, water tank and coffee spouts. Use a soft cloth, hot water and a mild detergent. None of these machine components can be washed in a dishwasher. Do not use solvents, abrasive detergents or alcohol to clean the coffee machine. Regularly check that the ground coffee funnel is not blocked. If necessary, remove any coffee deposits with the supplied brush.

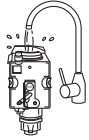

### **Brewing unit**

The brewing unit **A8** can only be removed when the machine is switched off (and not in the Ready to use state) by pressing the "On/Stand-by"  key for 3 seconds. Press the two coloured release buttons inwards and, at the same time, pull the brewing unit outwards. Do not use detergents to clean the brewing unit. It would remove the lubricant applied to the inside of the piston. Soak the brewing unit in water for about 5 minutes, then rinse. **DO NOT PLACE THE BREWING UNIT IN THE DISHWASHER.**

### **Rinsing**

If the machine is not used for more than 3/4 days, before using it again, it is strongly advisable to switch it on and run 2-3 rinse cycles by pressing "Maintenance" and selecting "Rinsing"



### **Hot water/steam connection nozzle**

Each time milk is prepared, the hot water/steam connection nozzle **A5** must be cleaned with a clean cloth to remove any milk residue from the seals.

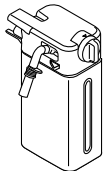

### **Milk container**

components

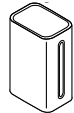

dishwashers



Make sure there are no milk residues on the hollow and groove under the dial. If necessary, scrape the groove with a toothpick.

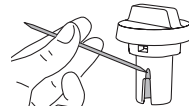

### **Drip tray and used coffee grounds container**

components

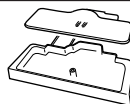

dishwashers



## 8. DESCALING

The machine is designed to detect when the descaling procedure is required.

To run the descaling procedure yourself, proceed as follows:

1. Remove the water softener filter **B4** from the water tank **A7** (if previously inserted)
2. Select "Maintenance".
3. Select "Descaling" and follow the instructions on the display.

The descaling cycle cannot be cancelled but only temporarily interrupted, by pressing "STOP".

Use only descaler authorized by the manufacturer.

WebShop AEG: [www.aeg.com/shop](http://www.aeg.com/shop)

## 9. SETTING WATER HARDNESS

The machine is set by default for a hardness level of 4. The machine setting can be changed according to the effective hardness of the water in various regions, thus making descaling less frequent.

### 9.1 Measuring water hardness

1. Remove the "Total hardness test" **B1** strip (included in the Quick Guide) from its packaging.
2. Immerse the paper completely in a glass of water for one second.
3. Remove the paper from the water and shake lightly. After about a minute, 1, 2, 3,

or 4 red squares form, depending on the hardness of the water. Each square corresponds to one level.

### 9.2 Measuring water hardness

1. Select "Settings", "Setup".
2. Select "Water Hardness" and set the required level from 1 to 4 (Level 1 = soft water; Level 4 = very hard water).

The machine is now reprogrammed with the new water hardness setting.

## 10. SOFTENER

Certain models have a water softener filter **B4**

. If this is not the case with your model, you are recommended to purchase one from Customer Services. The filter has a service life of roughly two months with normal machine use. If the coffee machine is left unused with the filter installed, it will last a maximum of 3 weeks.

### 10.1 Installing the filter

1. Remove the filter from its packaging.
2. Select "Maintenance".
3. Select "Water Softener Filter" and follow the instructions on the display.
4. Select "Install".

### 10.2 Removing the filter

1. Select "Maintenance".
2. Select "Water Softener Filter" and follow the instructions on the display.
3. Select "Remove" and follow the instructions on the display.

### 10.3 Replacing the water softener filter

1. Select "Maintenance".
2. Select "Replace" and follow the instructions on the display.

Use only a water filter approved by the manufacturer:

WebShop AEG: [www.aeg.com/shop](http://www.aeg.com/shop).  
cod. **9029798726 M3BICF200**

## 11. TECHNICAL DATA

Voltage: 220-240 V~ 50-60 Hz max. 10A  
Absorbed power: 1350W  
Pressure: 15 bar  
Water tank capacity: 2.5 litres  
Size: LxHxD: 594x454x412mm  
Weight: 20 kg



This machine complies with Regulation EC 1935/2004 concerning materials and articles intended to come into contact with food.

## 12. ENVIRONMENT CONCERNS

Recycle materials with the symbol . Put the packaging in relevant containers to recycle it. Help protect the environment and human health by recycling waste of electrical and electronic appliances.

Do not dispose appliances marked with the symbol  with the household waste. Return the product to your local recycling facility or contact your municipal office.

## 13. ENERGY EFFICIENCY

### 12.1 Product information concerning power consumption and the maximum time required to reach the applicable low-power mode

Power consumption when the product is off	0 W
Power consumption in stand-by mode with the display on	0.8 W
Power consumption in stand-by mode with the display off	0.5 W
Time required for the appliance to automatically reach the applicable low-power mode	20 min

## 14. DISPLAYED MESSAGES

Displayed message	Possible cause	Remedy
EMPTY GROUND COFFEE WASTE CONTAINER	The coffee grounds container is full.	Empty the used coffee grounds container, clean and refit it. <b>IMPORTANT:</b> the container may not be full. This is a normal cleaning message that prevents the formation of mould after a certain period of time.
INSERT GROUND COFFEE WASTE CONTAINER	The used coffee grounds container is not positioned correctly.	Properly insert the used coffee grounds container after cleaning.

Displayed message	Possible cause	Remedy
ADD PRE-GROUND COFFEE OR CLEAN GROUND COFFEE FUNNEL	The pre-ground coffee function has been selected but no pre-ground coffee has been poured into the funnel.	Pour pre-ground coffee into the funnel and repeat delivery
	The pre-ground coffee funnel is clogged.	Empty the funnel with the aid of a brush.
GROUND TOO FINE. ADJUST GRIND LEVEL	The grinding is too fine and the coffee is delivered too slowly or not at all.	Repeat coffee delivery and turn the grinding adjustment dial one click clockwise towards "7" while the coffee mill is in operation. If, after preparing at least 2 coffees, delivery is still too slow, repeat the correction procedure by turning the grind adjustment dial by another click until delivery is right. If the problem persists, check that the water tank is properly inserted.
	If the water softener filter is present, an air bubble may have formed inside the circuit, obstructing delivery.	Insert the hot water/steam spout in the machine and deliver a little water until the flow becomes regular. Check that the filter has been properly installed (see the Quick Guide)
TOO MUCH PRE-GROUND COFFEE. REDUCE THE AMOUNT OR SELECT A Milder TASTE.	Too much coffee has been used.	Select a milder taste or reduce the quantity of pre-ground coffee (maximum 1 measure).
INSERT BREWING UNIT	The brewing unit is not positioned correctly	Insert the brewing unit properly after cleaning.
PLEASE DESCALE YOUR MACHINE	The machine must be descaled.	Follow the instructions and procedure on the display
PLEASE DESCALE YOUR MACHINE: YOU HAVE ## BEVERAGES LEFT.	The machine must be descaled.	Select "Maintenance" and then "Descaling" to start descaling. Follow the instructions and procedure on the display.
REPLACE WATER SOFTENER FILTER	The water softener filter is worn.	Follow the instructions on the display to replace or remove the filter. Follow the instructions in section "Water softener filter".
ERROR OCCURRED. PLEASE CONTACT TECHNICAL ASSISTANCE FOR SUPPORT.	The inside of the machine is very dirty.	Thoroughly clean the inside of the machine, as described in the "Cleaning" section. If the message is still displayed after cleaning, contact Customer Services.
STORE MILK CONTAINER IN THE FRIDGE	The milk container has been in the machine for more than 20 minutes	Remove the milk container from the machine and place it in the fridge.
ASSEMBLE THE SPOUT ON THE MILK CONTAINER	First request for a milk-based beverage	Follow the instructions on the display

## 15. TROUBLESHOOTING

Problem	Possible cause	Remedy
The coffee is not hot.	A low coffee temperature is set.	Increase the coffee temperature in the settings.
	The cups were not preheated.	Heat the cups with hot water: select "Maintenance" and then "Rinsing". Throw the water away and dry the cups carefully.
	The machine has cooled because some time has passed since the last coffee was prepared.	Heat the coffee spouts by running a rinse: select "Maintenance" and then "Rinsing"
	The machine needs descaling	Proceed as described in the "Descaling" section. Then, check the water hardness ("Measuring water hardness") and check that the machine setting matches the local water hardness ("Water hardness setting").
The coffee is weak or not creamy enough.	The coffee is ground too coarsely.	Turn the grinding adjustment dial one click anticlockwise towards "1" while the coffee mill is in operation. Continue one click at a time until coffee delivery is satisfactory. The effect is only visible after delivering 2 coffees (see section "Adjusting the coffee mill").
	The coffee is not fresh.	The coffee package was left open for too long and the coffee has lost its aroma.
	The coffee is unsuitable.	Use coffee for espresso machines.
The coffee is delivered too slowly or a drop at a time.	The coffee is ground too finely.	Turn the grinding adjustment dial one click clockwise towards "7" while the coffee mill is in operation. Continue one click at a time until coffee delivery is satisfactory. The effect is only visible after delivering 2 coffees (see section "Adjusting the coffee mill").
Coffee does not come out of one or both of the spouts.	The coffee spouts are blocked.	Clean the spouts with a toothpick and run the rinse procedure.
The machine does not start	It is not plugged into the mains socket.	Plug into the mains socket.
	The main switch is not on.	Press the main switch <b>A1</b> .
The brewing unit cannot be removed	The machine is not switched off correctly	Switch the machine off by pressing the "On/Stand-by" <b>ⓘ</b> key for 3 seconds.
At the end of descaling, the machine requests a third rinse	During the two rinse cycles, the water tank is not filled to the MAX level	Follow the instructions on the machine display, but first empty the drip tray to prevent the water from spilling out.
The milk does not come out of the milk spout	The milk container lid is dirty	Clean the milk container lid

<b>Problem</b>	<b>Possible cause</b>	<b>Remedy</b>
The milk contains large bubbles and squirts out of the milk spout or there is little froth	The milk is not cold enough or is not semi-skimmed or skimmed.	Use skimmed or semi-skimmed milk at refrigerator temperature (about 5° C). If the result is not as you wished, try changing brand of milk.
	The froth adjustment dial is incorrectly adjusted.	Adjust following the instructions in section "Adjusting the amount of froth".
	The milk container lid or froth adjustment dial is dirty	Clean the milk container lid and froth adjustment dial as described in section "Cleaning the milk container".
	The hot water and steam connection nozzle is dirty	Clean the connection nozzle as described in section "Cleaning the hot water/steam connection nozzle".
The machine emits noises or small puffs of steam while not in use	The machine is ready for use, or has recently been turned off, and condensate is dripping into the hot vaporiser	This is part of normal operation. To limit the phenomenon, empty the drip tray.







**aeg.com**

DEMO MODE CODE: 2.4.6.8

To exit Demo mode, select "Settings", "Service" and "Demo Mode".

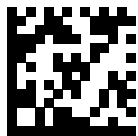

57132C8602\_04\_1024

