

User manual
Washing machine

HW80-B14959EU1

HW90-B14959EU1

EN

Haier

Thank you for purchasing a Haier Product.

Please read these instructions carefully before using this appliance. The instructions contain important information which will help you get the best out of the appliance and ensure safe and proper installation, use and maintenance.

Keep this manual in a convenient place so you can always refer to it for the safe and proper use of the appliance.

If you sell the appliance, give it away, or leave it behind when you move house, make sure you also pass this manual so that the new owner can become familiar with the appliance and safety warnings.



Legend

Warning – Important Safety information



General information and tips



Environmental information



Disposal

Help protect the environment and human health. Put the packaging in applicable containers to recycle it. Help to recycle waste of electrical and electronic appliances. Do not dispose appliances marked with this symbol with the household waste. Return the product to your local recycling facility or contact your municipal office.



WARNING!

Risk of injury or suffocation!

Disconnect the appliance from the mains supply. Cut off the mains cable and dispose of it. Remove the door catch to prevent children and pets to get closed in the appliance.



Note: Pictures

All pictures are schematic

1-Safety information.....	4
2-Product description	7
3-Control panel	8
4-Programmes	12
5-Consumption.....	13
6-Daily use	14
7-hOn.....	19
7-Eco friendly use.....	22
8-Care and cleaning	23
9-Troubleshooting	26
10-Installation.....	29
11-Technical data.....	33
12-Customer service.....	34

Before switching on the appliance for the first time read the following safety hints!:



WARNING!

Before first use

- ▶ Make sure there is no transport damage.
- ▶ Make sure all transport bolts are removed.
- ▶ Remove all packaging and keep out of children's reach.
- ▶ Handle the appliance always with at least two persons because it is heavy.

Daily use

- ▶ This appliance can be used by children aged from 8 years and above and persons with reduced physical, sensory or mental capabilities or lack of experience and knowledge if they have been given supervision or instruction concerning use of the appliance in a safe way and understand the hazards involved.
- ▶ Keep away children under 3 years of age from the appliance unless they are constantly supervised.
- ▶ Children shall not play with the appliance.
- ▶ Do not let children or pets come close to the appliance when the door is open.
- ▶ Store washing agents out of reach of children.
- ▶ Pull up zips, fix loose threads and take care for small items to prevent laundry from being entangled. If necessary, use an appropriate bag or net.
- ▶ Do not touch or use the appliance when barefoot or with wet or damp hands or feet.
- ▶ Do not cover or encase the appliance during operation or afterwards to allow any moisture or dampness to evaporate.
- ▶ Do not place heavy objects or sources of heat or damp on top of the appliance.
- ▶ Do not use or store flammable detergent or dry cleaning agent in close vicinity to the appliance.
- ▶ Do not use any flammable sprays in close vicinity to the appliance.
- ▶ Do not wash any garments treated with solvents in the appliance without having dried them previously in the air.
- ▶ Do not remove or insert the plug in the presence of flammable gas

**WARNING!****Daily use**

- ▶ Do not hot wash foam rubber or sponge-like materials.
- ▶ Do not wash any laundry which is polluted with flour.
- ▶ Do not open detergent drawer during any wash cycle.
- ▶ Do not touch the door during the washing process, it gets hot.
- ▶ Do not open the door if the water level is visibly over the porthole.
- ▶ Do not force the door to open. The door is fitted with a self-lock device and will open shortly after the washing procedure is ended.
- ▶ Switch off the appliance after each wash programme and before undertaking any routine maintenance and disconnect the appliance from the electrical supply to save electricity and for safety.
- ▶ Hold the plug, not the cable, when unplugging the appliance.

Maintenance / cleaning

- ▶ Make sure children are supervised if they carry out cleaning and maintenance.
- ▶ Disconnect the appliance from the electrical supply before undertaking any routine maintenance.
- ▶ Keep the lower part of the porthole clean and open door and detergent drawer if appliance is not in use to prevent odours.
- ▶ Do not use water spray or steam to clean the appliance.
- ▶ Replace a damaged supply cord only by the manufacturer, its service agent or similarly qualified persons in order to avoid a hazard.
- ▶ Do not try to repair the appliance by yourself. In case of repair please contact our customer service.

Installation

- ▶ The appliance should be placed in a well-ventilated place. Ensure a location which allows opening the door fully.
- ▶ Never install the appliance outdoors in a damp place, or in an area which may be prone to water leaks such as under or near a sink unit. In the event of a water leak cut power supply and allow the machine to dry naturally.



WARNING

Installation

- ▶ Install or use the appliance only where the temperature is above 5 °C.
- ▶ Do not place the appliance directly on a carpet, or close to a wall or furniture
- ▶ Do not install the appliance in direct sunlight or in the near of heat sources(e.g. stoves, heaters).
- ▶ Make sure that the electrical information on the rating plate agrees with the power supply. If it does not, contact an electrician.
- ▶ Do not use multi-plug adapters and extension cables.
- ▶ Make sure only the delivered electric cable and hose set are used.
- ▶ Make sure not to damage the electric cable and the plug. If damaged have it replaced by an electrician.
- ▶ For the power supply, use a separate earthed socket which is easily accessible after installation. The appliance must be earthed.
Only for UK: The appliance's power cable is fitted with 3-cord (grounding) plug that fits a standard 3-cord (grounded) socket. Never cut off or dismount the third pin (grounding). After the appliance is installed, the plug should be accessible.
- ▶ Make sure the hose joints and connections are firm and there is no leakage.

Intended use

This appliance is intended for washing machine-washable laundry only. Anytime follow the instructions given on the label of each garment label. It is designed exclusively for domestic use inside the house. It is not intended for commercial or industrial use.

Changes or modifications to the device are not allowed. Unintended use may cause hazards and loss of of all warranty and liability claims.

Note: Deviations

Due to technical changes and different models, the illustrations in the following chapters may differ from your model.

2.1 Picture of appliance

Front (Fig. 2-1):



Rear side (Fig. 2-2):

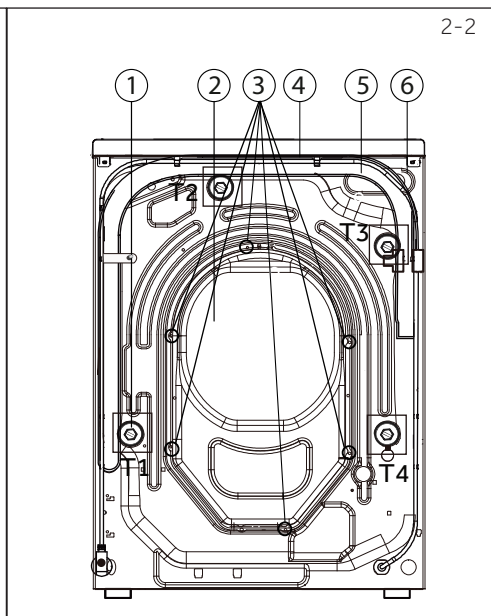

- 1 Detergent / Softener drawer
- 2 Worktop
- 3 Control panel
- 4 Washer door
- 5 Filter cover
- 6 Adjustable feet

- 1 Transportation bolts (T1-T4)
- 2 Backcover
- 3 Backcover screws
- 4 Power cord
- 5 Drain hose
- 6 Water inlet valve

2.2 Accessories

Check the accessories and literature in accordance with this list (Fig. 2-3)

2-3



Inlet hose



5 Blanking plugs



Drain hose bracket



Noise reduction pads



Warranty card



Energy label



User manual

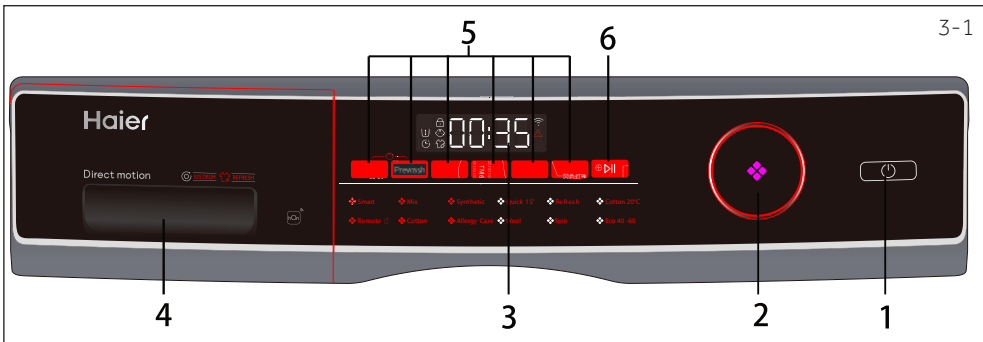

- | | | |
|----------------------|---------------------------------|------------------------|
| 1 "Power" button | 3 Display | 5 Function buttons |
| 2 Programme selector | 4 Detergent/
Softener drawer | 6 "Start/Pause" button |



Note: Acoustic signal

In following cases, an acoustic signal is no sounds by default:

- ▶ when pressing the button
- ▶ when turning the programme selector
- ▶ at the end of programme

The acoustic signal can be selected if necessary: see DAILY USE (P18, 6.13)

3-2

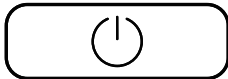

3.1 "Power" button

Touch this button (Fig. 3-2) gently to switch on, the display is shining, the indicator of the "Start/Pause" button is flashing. Touch it again for about 2 sec. to switch off. If no panel element or programme is activated after a while machine will shut down automatically.



Note: Power off

Without Wi-Fi connection, the switched-on appliance automatically powers off it is not activated within 2 minutes before starting the programme or at the end of the programme. With Wi-Fi connection, the waiting time duration is 24h.

3-3



3.2 Programme selector







By turning the knob (Fig. 3-3) one of 12 programmes can be selected, related LED will light up, its default settings will be displayed.

3.3 Display

The display (Fig. 3-4) shows following information:

- ▶ Washing time
- ▶ End time delay
- ▶ Error codes and service information
- ▶ Display symbols
- ▶ Speed, Temperature, etc.



Symbols	Meaning	Symbols	Meaning
	Drum door is locked		Alarm
	Control panel is locked		Pre-wash
	Steam		Delay
	Appliance is connected to WiFi		

3.4 Function buttons

The function buttons (Fig. 3-5) enables additional options in the selected programme before programme starts. The related indicators are displayed. By switching off the appliance or setting a new programme, all options are disabled. If a button has multiple options, the desired option can be selected by pressing the button sequentially.

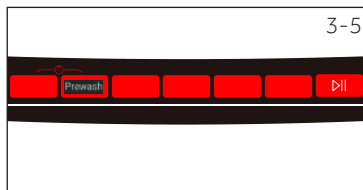

Note: Factory settings

To get the best results in each programme Haier has well defined specific default settings. If there is no special requirement default settings are recommended.

3.4.1-Function button "Delay"

Press this button (Fig. 3-6) to start the programme with a delay. End time delay could be increased in steps of 30 minutes from 0,5-24h (End time will be longer than original programme time). For example display off 6:30 means end of programme cycle will be in 6 hours and 30 minutes. Touch "Start/Pause" button to activate the time delay. It is not applicable to programme "Spin", "Refresh" and "Remote".

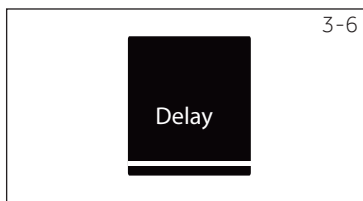

Note: Liquid detergent

If using liquid detergent, it is not recommended to activate the end time delay.

3-7



3.4.2-Function button "Prewash"

Touch this button (Fig. 3-7) the "Prewash" programme can be selected. When selecting this function, you need to add a little detergent in the Prewash area in advance (pay attention to the detergent should not exceed 30g). Mix, Synthetic, Cotton 20°C, Cotton, Allergy Care can select this function, when you select the Prewash function, the icon will light up.

3-8



3.4.3 Function button "Temp."

Press this button (Fig. 3-8) to change the washing temperature of the programme. If no value is illuminated (the display "--") the water will not be heated.

3-9



3.4.4 Function button "Speed"

Press this button (Fig. 3-9) to change or deselect the spin of the programme. If no value is illuminated (the display "0") the laundry will not spin.

3-10



3.4.5 Function button "Extra Rinse"

Press this button (Fig. 3-10) to rinse the laundry more intensely with fresh water. This is recommended for people with sensitive skin. By touching the button several times zero to three additional cycles can be selected. They appear in the display with P--0/P--1/P--2/P--3. Different programme options are different.

3-11



3.4.6 Function button "i-time"

This function (Fig. 3-11) intensifies different washing time. Not all programmes can select this function. See P12 for programmes that can select this function.

3-12



3.4.7 Function button "Start/Pause"

Touch this button (Fig. 3-12) gently to start or interrupt the currently displayed programme.

3.5 "Child lock"

Choosing a programme and then start, touch button "Delay" and "Prewash" (Fig. 3-13) for 3 seconds simultaneously to block all panel elements against activation, panel displays . For unlocking, please touch again the two buttons. The child lock indicator lights up when the child lock works. Feature is optional when the machine is running.

The display shows **CL01** (Fig. 3-14) if a button will be pressed, when the child lock is activated. The change is not running.



Note: Child lock

- ▶ The child lock which is set up manually must be cancelled manually or will be cancelled automatically at the end of the programme. Power off and error information won't cancel child lock. It still works when the appliance is powered on next time.
- ▶ If you use the child lock, first press the programme key, then the child lock will be on.
- ▶ Hold it for 3 seconds, the child lock will turn to full light and the child lock will be activated.
- ▶ Child lock can't be set up or cancelled through hOn App.

3.6 Detergent drawer

Open dispenser drawer, the following components can be seen (Fig. 3-15):

- 1: The main washing compartment for powder or liquid detergent.
- 2: Detergent flap selector, lift it up for powder detergent, keep it down for liquid detergent.
- 3: Compartment for softener.
- 4: Pre-wash compartment for a small amount of powder detergent.
- 5: Lock tab, press it down to pull out dispenser drawer.

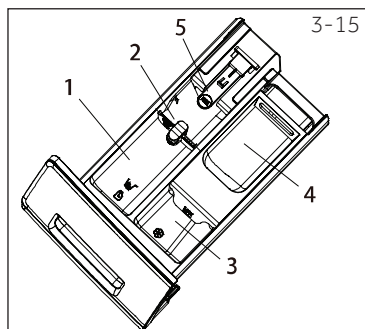

The recommendation on the type of detergents is suitable for the various washing temperatures, please refer to the manual of detergent.

Note: The procedure to check the number of cycles that the machine has run.

Procedure: under standby mode, select "Cotton" program first, then touch "Temp." and "Speed" at the same time, it will display the number of running cycles for 2 seconds, and then back to standby interface. The cumulative running cycles will add 1 after the programme ends. The running cycles will be displayed in hexadecimal if it is over 9999.

4-Programmes

EN

● Yes, ○ Optional, / No

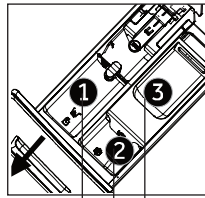

Detergent compartment for:

- ① Detergent
- ② Softener or care product
- ③ Detergent ³⁾

Programme	Max. load in kg HW80/90	Temperature in °C ¹⁾ selectable range	Preset	1	2	3	Fabrics type	Preset spin speed in rpm	Function				
									Delay	Prewash	Extra Rinse	i-time	Default duration HW80/90
Smart	8/9	* to 60	30	●	○	○	Lightly soiled mixed laundry of cotton and synthetics	1000	●	/	●	●	1:03 1:08
Mix	8/9	* to 60	30	●	○	○	Lightly soiled mixed laundry of cotton and synthetics	1000	●	●	●	●	1:05 1:10
Synthetics	4/4.5	* to 60	40	●	○	○	Synthetics or mixed fabric	1200	●	●	●	●	2:08 2:13
Quick 15 ²⁾	2	* to 40	*	●	○	○	Cotton/Synthetics	1000	●	/	●	●	0:15 0:15
Refresh	1	/	/	/	/	/	Cotton/Synthetics	/	/	/	/	/	0:18 0:18
Cotton 20°C	8/9	/	/	●	○	○	Cotton	1000	●	●	●	●	0:53 0:53
Remote	/	/	/	/	/	/	/	/	/	/	/	/	0:49 0:49
Cotton	8/9	* to 90	40	●	○	○	Cotton	1400	●	●	●	●	1:17 1:22
Allergy Care	8/9	* to 90	60	●	○	○	Cotton/Synthetics	1000	●	●	●	●	1:42 1:47
Wool	2/2.5	* to 40	*	●	○	/	Machine-washable fabric made of wool or with wool content	800	●	/	●	●	0:40 0:40
Spin	8/9	/	/	/	/	/	Non-fragile fabric	1000	/	/	/	/	0:08 0:08
ECO-40-60	8/9	/	/	●	○	○	/	/	●	/	/	/	2:31 2:31

* Water is not heated up.

¹⁾ Choose 90 °C wash temperature only for special hygienic requirements.

²⁾ Reduce detergent amount because programme duration is short.

³⁾ No or a small amount of powder detergent.

⁴⁾ Relating to dry laundry.

The design and specifications are subject to change without notice for quality improvement purposes. User shall not add any sanitizer, detergent or softener to the i-Refresh function.

Scan QR code on energy label for energy consumption information.

The actual energy consumption may differ from the declared one according to local conditions.







Note: Auto Weight

The appliance is equipped with a loading recognition. At low loading, energy, water and washing time will be reduced automatically in some programmes.

The display default time may vary depending on the load weight, involving the "Smart, Mix, Synthetics, Cotton, Cotton 20° C, Eco 40-60" programme.

Indicative information (as per Commission Regulation (EU) 2019/2023):

Rated Capacity	Programme			ENERGY 		Max. Temperature	Effective Speed	
		(kg)	(HH:MM)	(kWh/cycle)	(L/cycle)	(°C)	(RPM)	Residual Moisture (%)
8 kg	Eco 40-60	8.0	3:38	0.550	60.0	28	1330	53.5
	Eco 40-60	4.0	2:48	0.335	37.0	26	1330	53.2
	Eco 40-60	2.0	2:38	0.226	33.0	25	1330	55.0
	Cotton 20°C	8.0	0:53	0.280	75.0	20	1000	65.0
	Cotton 60°C	8.0	1:46	1.800	75.0	57	1400	55.0
	Wool 30°C	1.0	0:45	0.350	38.0	30	800	37.0
	Quick15'30°C	1.0	0:23	0.350	38.0	30	1000	65.0
9 kg	Eco 40-60	9.0	3:48	0.680	65.0	30	1330	53.4
	Eco 40-60	4.5	2:52	0.380	39.0	28	1330	53.0
	Eco 40-60	2.5	2:38	0.230	35.0	25	1330	55.0
	Cotton 20°C	9.0	0:53	0.300	80.0	20	1000	65.0
	Cotton 60°C	9.0	1:46	2.000	80.0	57	1400	55.0
	Wool 30°C	1.0	0:45	0.380	40.0	30	800	37.0
	Quick15'30°C	1.0	0:23	0.380	40.0	30	1000	65.0

The values given for programmes other than the Eco 40- 60 programme and the dry cycle are indicative only.

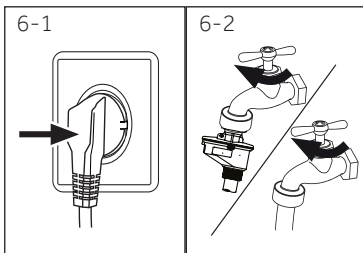

6.1 Power supply

Connect the washing machine to a power supply (220V to 240V~/50Hz; Fig. 6-1). Please refer also to section INSTALLATION (see P28).

6.2 Water connection

- ▶ Before connecting check the cleanliness and clarity of the water inlet.
- ▶ Turn on the tap (Fig.6-2).

i Note: Tightness

Before use check for leakage in the joints between the tap and the inlet hose by turning on the tap.

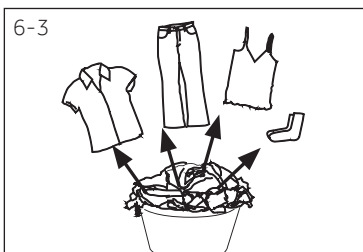

6.3 Preparing laundry

- ▶ Sort out clothes according to fabric (cotton, synthetics, wool or silk) and to how dirty they are (Fig. 6-3). Pay attention to the care labelling of washing labels.
- ▶ Separate white clothes from coloured ones. Wash coloured textiles first by hand to check if they fade or run.
- ▶ Empty pockets (keys, coins, etc.) and remove harder decorative objects (e.g. brooches).
- ▶ Garments without hems, delicates and finely woven textile such as fine curtains are to be put into a wash bag to care for this delicate laundry (hand or dry cleaning would be better).
- ▶ Close zippers, velco fastener and hooks, make sure the buttons are sewn on tightly.
- ▶ Place sensitive items like laundry without firm hem, delicate underwear (Dessous) and small items such as socks, belts, bras, etc. in a wash bag.
- ▶ Unfold large pieces of fabric such as bed sheets, bedspreads etc.
- ▶ Turn jeans and printed, decorated or color-intensive textiles inside out; possibly wash separately.

! CAUTION!

Non-textile, as well as small, loose or sharp-edged items may cause malfunctions and damage of clothes and appliance.

6.4 Care chart

Washing		
 Washable up to 95°C normal process	 Washable up to 60°C normal process	 Washable up to 60°C mild process
 Washable up to 40°C normal process	 Washable up to 40°C mild process	 Washable up to 40°C very mild process
 Washable up to 30°C normal process	 Washable up to 30°C mild process	 Washable up to 30°C very mild process
 Wash by hand max. 40°C	 Do not wash	
Bleaching		
 Any bleaching allowed	 Only oxygen/non-chlorine	 Do not bleach
Drying		
 Tumble drying possible normal temperature	 Tumble drying possible lower temperature	 Do not tumble dry
 Line drying	 Flat drying	
Ironing		
 Iron at a maximum temperature up to 200 °C	 Iron at a medial temperature up to 150°C	 Iron at a low temperature up to 110 °C; without steam (steam ironing may cause irreversible damage)
 Do not iron		
Professional Textile Care		
 Dry cleaning in tetra-chloroethene	 Dry cleaning in hydrocarbons	 Do not dry clean
 Professional wet clean	 Do not professional wet clean	

Not all of these symbols are displayed in the appliance menu.

6.5 Loading the appliance

- ▶ Put in the laundry piece by piece into the drum.
- ▶ Don't overload. Note the different maximum load according to programmes. Check if you can put a hand upright on top of the load.
- ▶ Close the door carefully. Make sure that no pieces of laundry are pinched.

6.6 Selecting detergent

- ▶ Washing efficiency and performance is determined by used detergent quality.
- ▶ Use only machine wash approved detergent.
- ▶ If needed use specific detergents, e.g. for synthetic and woolen fabric.
- ▶ Mind always detergent manufacturer recommendations.
- ▶ Do not use dry cleaning agents such as trichloroethylene and similar products.

Programme	Kind of detergent				
	Universal	Colour	Delicate	Special	Softener
Smart	L/P	L/P	-	-	o
Mix	L	L/P	-	-	o
Synthetics	-	L/P	-	-	o
Quick 15'	L	L	-	-	o
Refresh	-	-	-	-	-
Cotton 20°C	L/P	L/P	-	-	o
Remote 	L/P	L/P	-	L	-
Cotton	L/P	L/P	-	-	o
Allergy Care	L/P	L/P	-	-	o
Wool	-	-	L/P	L/P	o
Spin	-	-	-	-	-
Eco 40-60	L/P	L/P	-	-	o

L = gel-/liquid detergent

P = powder detergent

O = optional

- = no

If using liquid detergent, it is not recommended to activate the time delay.

We recommend by using:

- ▶ Laundry powder: 20°C to 90°C* (best use: 40-60°C)
- ▶ Color detergent: 20°C to 60°C (best use: 30-60°C)
- ▶ Wool/delicate detergent: 20°C to 30°C (= best use: 20°C to 30°C)

* Choose 90 °C wash temperature only for special hygienic requirements.

* If you choose the water temperature 60°C or above, we would like to advise you to use less detergent. Please kindly use the special disinfectant, which is suitable for cotton or synthetic cloth.

* It is better to use less or free suds detergent powder.

6.7 Adding detergent

1. Slide out the detergent drawer.
2. Put the required chemicals into corresponding compartments (Fig. 6-4)
3. Push back the drawer gently.

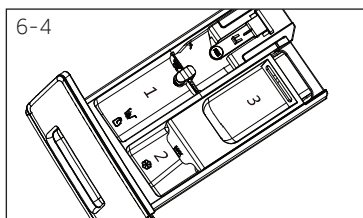

i Note:

- ▶ Remove detergent residues before next wash cycle from the detergent drawer.
- ▶ Do not overuse detergent or softener.
- ▶ Please follow the instruction on the detergent package.
- ▶ Always fill the detergent just before the beginning of the wash cycle.
- ▶ Concentrated liquid detergent should be diluted before adding.
- ▶ Do not use liquid detergent if "Delay" is selected.
- ▶ Carefully choose the programme settings according to the care symbols on all laundry labels and according to the programme table.

6.8 Switch on the appliance

Touch the "Power" - button to switch on the appliance (Fig. 6-5). The LED of the "Start/Pause" button is flashing.

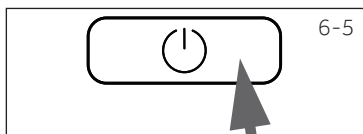

6.9 Select a programme

To get the best washing results, select a programme which fits the degree of soiling and sort of laundry type.

Turn the programme knob (Fig. 6-6) to select the right programme. Related programme LED lights up and the default settings are displayed.

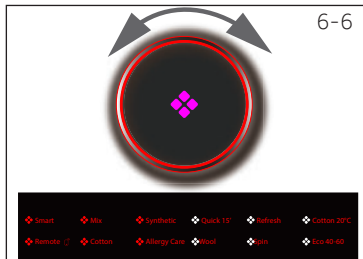

i Note: Odor removal

Before first use we recommended to run programme "Cotton + 90° + 600rpm" with no load and small amount of detergent in washing agent compartment or special machine cleaner to remove possibly corruptive residues.

6.10 Add individual selections

Select required options and settings (Fig. 6-7); refer to CONTROL PANEL.

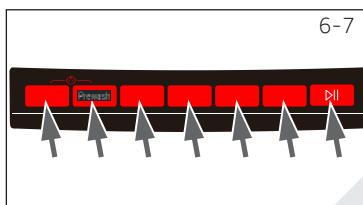

6-8



6.11 Start wash programme

Touch "Start/Pause" button (Fig. 6-8) to start. The LED of the "Start/Pause" button stops flashing and lights up continuously. Appliance operates according to present settings. Changes are only possible by cancelling the programme.

6.12 Interrupt / cancel wash programme

To interrupt a running programme press gently "Start/Pause". The LED above the button is flashing. Press it again to resume operation.

To cancel a running programme and all its individual settings

1. Touch "Start/Pause" button to interrupt the running programme.
2. Touch "Power" button for about 2 seconds to switch the appliance off.
3. Touch the "Power" button to turn on the appliance, select "no Speed" (speed lights are off) and run programme "Spin" to drain the water.
4. After closing the programme to restart the appliance, select a new programme and start it.

6.13 After washing



Note: Door lock

- ▶ For safety reasons the door is locked partially during the washing cycle. It is only possible to open the door at the end of the programme or after the programme was cancelled correctly (see description above).
- ▶ In case of high water level, high water temperature and during spinning it is not possible to open the door; **LoCk** is displayed

1. At programme cycle end **End** is displayed.
2. The appliance switches off automatically.
3. Remove laundry as soon as possible to go easy on it and to prevent more wrinkling.
4. Turn off the water supply.
5. Unplug the power cord.
6. Open the door to prevent formation of moisture and odours. Let it open while not used.
7. Small clothes are easy to stick to the wall after high-speed swing drying, please do not omit when opening the door to pick up clothes.



Note: Standby mode / energy-saving mode

The switched on appliance will go into standby-mode if it will not be activated within 2 minutes before starting the program or at the end of program. The display switches off. This saves energy. To interrupt the standby mode push "Power" button.

6.14 Activate or deactivate the buzzer

The acoustic signal can be deselected if necessary:

1. Switch on the appliance.
2. Select the "Mix" programme.
3. Touch the "Prewash" button and "Speed" button at the same time for about 3 seconds. **bEEP on** will be displayed and the buzzer will be activated. For deactivating the buzzer press these two buttons at the same time again. **bEEP off** will be displayed.

Note: Deviations

Due to constant updates of hOn, the functions and the display interface of the APP may differ from the following description.

7.1 General

This appliance is Wi-Fi enabled. With hOn APP you can use your smartphone to control the program.



WARNING!

Please observe the safety precautions in this user manual and make sure that these are complied with even when operating the appliance via the hOn APP while you are away from home. You must also follow the instructions in the hOn.

7.2 Requirements

1. One wireless router (802.11b/g/n protocol) which supports only the frequency band of 2.4 GHz. Length of Router SSID is 1-31 characters(including 1 and 31), and password is 8-64 characters. Minimum length of password must be 8 characters. Router encryption methods include open, WPA-PSK and WPA2-PSK.
2. The App is available for devices running Android, Huawei or iOS, both for tablets and for smartphones.
3. The appliance shall be installed in a position where it can receive a strong Wi-Fi signal. Once the appliance has been correctly associated with the APP, if it's not properly connected to the wireless router, no Wi-Fi icon appears on the display

7.3 Download and installation of hOn APP:

Download the hOn App on your device by framing the following QR code:



or by the link: go.haier-europe.com/download-app

Note: Registration

Registration is required when first time to use or the formal account has been deleted/closed. For further use, you need to enter user name and password after you log in.

7.4 Registration and App Pairing

1. Connect the smartphone to the home Wi-Fi network you want to connect the product to.
2. Open the App.
3. Create the user profile (or log-in if it is already created previously)
4. Close the door
5. Pairing the appliance following the instructions on the device display.



Note: Wi-Fi Network

It is not possible to connect the appliance to a public Wi-Fi network. It may cause malfunction.



Note: Use same Wi-Fi

Connect with your smartphone to the network you want to connect the product to.

7.5 Enable Remote Control

1. Check that the router is switched on and connected to the Internet.
2. Load the laundry and close the door.
3. Select the "Remote" programme, the door locks.
4. Start the cycle using the app, control panel will be disabled except for "Power" and "Start/Pause" button.
5. Once the cycle has been completed, the door unlocks and the remote control turns off.
6. After 2 minutes the appliance goes to off mode.



Note: Remote control expiration

Once the remote control is activated, if the end user doesn't start any cycle from app in 10 minutes, the appliance will go to Networked Delay Start Mode, and keeps remote control up to 24 hours, then shut off.

7.6 Disable Remote Control

1. To exit remote control while a cycle is running, press "Start/Pause" button on the control panel. The cycle will pause and "Remote" will blink.
2. If conditions permit, the door will unlock.
3. To resume the cycle, close the door and press "Start/Pause" button. The remote control will be reactivated and "Remote" will be fixed.
4. Control the appliance using the app.

7.7 End of Cycle With Remote Control On

1. At the end of the cycle, the door will unlock and the remote control will deactivate.
2. After 2 minutes the appliance will automatically switch off.



Note: Network credentials cancellation/reset

Follow this procedure only if you are going to sell your washer.

7.8 Network credentials cancellation

1. Select "Remote" programme;
2. "hOn"/"hOFF" displayed;
3. Long press "Delay" button for 5 seconds till "PRt r" displayed.
4. Configuration information is deleted and reset configuration. Rotate the knob to select other programme or shut down to exit.



Environmentally responsible use

Washing

- ▶ To achieve best use of energy, water, detergent and time you should use the recommended maximum load size.
- ▶ Do not overload (hand width clearance above laundry).
- ▶ For slightly soiled laundry select the Quick 15' programme.
- ▶ Apply exact dosages of each washing agent.
- ▶ Choose the lowest adequate washing temperature - modern detergents are efficiently cleaning below 60°C.
- ▶ Raise default settings only due to heavy staining.
- ▶ Spin the laundry with the maximum spin speed if you want to use a drying programme afterwards.



Note: General information:

- ▶ The "Eco 40-60" programme is able to clean normally soiled cotton laundry declared to be washable at 40°C or 60°C, together in the same cycle, and that this programme is used to assess the compliance with the EU ecodesign legislation;
- ▶ The most efficient programmes in terms of energy consumption are generally those that perform at lower temperatures and longer duration;
- ▶ Noise and remaining moisture content are influenced by the spinning speed: the higher the spinning speed in the spinning phase, the higher the noise and the lower the remaining moisture content.

9.1 Cleaning the detergent drawer

Take always care there are no detergent residues. Clean the drawer regularly (Fig. 9-1):

1. Pull out the drawer until it stops.
2. Press the release button and remove the drawer.
3. Wipe the inside of the sink clean with a towel.
4. Flush the drawer with water until it is clean and insert the drawer back in the appliance.

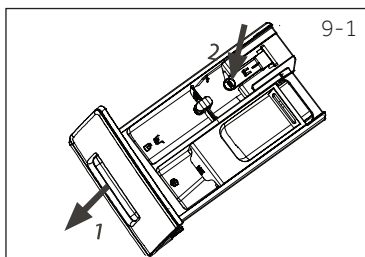

9.2 Cleaning the machine

- ▶ Unplug the machine during cleaning and maintenance.
- ▶ Use a soft cloth with soap liquid to clean the machine case (Fig. 9-2) and rubber components.
- ▶ Do not use organic chemicals or corrosive solvents.



9.3 Water inlet valve and inlet valve filter

To prevent blockage of water supply by solid substances like lime clean regularly the inlet valve filter.

- ▶ Unplug the power cord and turn off the water supply.
- ▶ Unscrew the water inlet hose at the back (Fig. 9-3) of the appliance as well as on the tap.
- ▶ Flush the filters with water and a brush (Fig. 9-4).
- ▶ Insert the filter and install the inlet hose.
- ▶ Turn on the tap to see if it leaks.

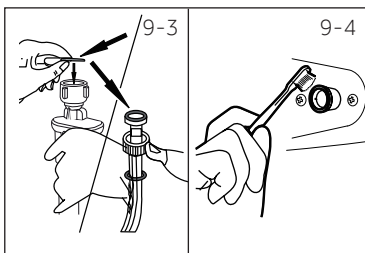

9.4 Cleaning the drum

- ▶ Remove accidentally washed items, especially metal parts such as pins, coins, etc. from the drum and the groove of the door gasket (rubber ring) because they cause rust stains and damage.
- ▶ Use a non-chloride cleaner for removing rust stains. Observe the warning hints of the cleaning agent manufacturer.
- ▶ Do not use any hard objects or steel wool for cleaning.
- ▶ After the procedure, open the door, use a towel to clean the stains and foam around the gasket, and keep the inside and outside of the gasket clean (Fig. 9-5).

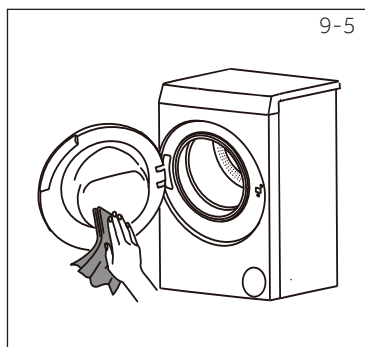

Note: Hygiene

For regular maintenance, we recommend running the program "COTTON+90 °C+600rpm" within 100 cycles to avoid possible corrosive residues. Add a small amount of detergent to the detergent compartment (2) or use a special machine cleaner.

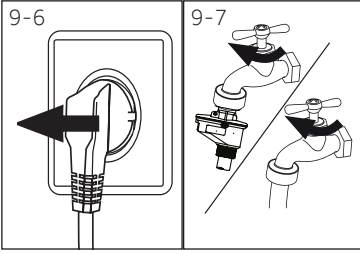

9.5 Long periods of disuse

If the appliance is left idle for a longer period:

1. Pull out the electrical plug (Fig. 9-6).
2. Turn off water supply (Fig. 9-7).
3. Open the door to prevent formation of moisture and odours. Let door open while not used.

Before next usage check carefully power cord, water inlet and drain hose. Make sure everything is properly installed and without leakage.

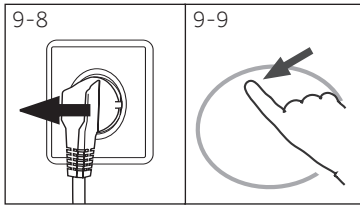

9.6 Pump filter

Clean the filter once a month and check the pump filter for instance if the appliance:

- ▶ Doesn't drain the water.
- ▶ Doesn't spin.
- ▶ Cause unusual noise while running.



WARNING!

Scalding Risk! Water in the pump filter can be very hot! Before any action please ensure water has cooled down.

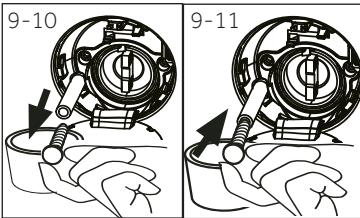

1. Turn off and unplug the machine (Fig. 9-8).
2. Open service flap. You can either use a coin or a screwdriver (Fig. 9-9).
3. Provide a flat container to catch leach water (Fig. 9-10). There could be bigger amounts!
4. Pull the drainhose out and hold its end above the container (Fig. 9-10).
5. Take the sealing plug out of the drainhose (Fig. 9-10).
6. After complete drainage close drainhose (Fig. 9-11). and push it back into the machine.

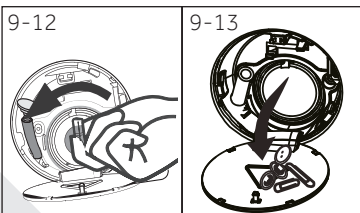

7. Unscrew and remove counter clockwise the pump filter (Fig. 9-12).
8. Remove contaminants and dirt (Fig. 9-13).

9. Clean carefully pump filter, e.g. using running water (Fig. 9-14).
10. Refix it thoroughly (Fig. 9-15).
11. Close service flap.

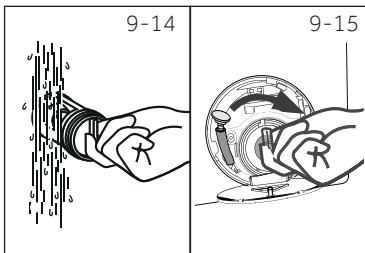
**CAUTION!**

- ▶ Pump filter sealing has to be clean and unhurt. If the lid is not full tightened, water can escape.
- ▶ The filter must be in place, or it may lead to leakage.

Many occurring problems could be solved by yourself without specific expertise. In case of a problem please check all shown possibilities and follow below instructions before you contact an after sales service. See CUSTOMER SERVICE.



WARNING!

- ▶ Before maintenance, deactivate the appliance and disconnect the mains plug from the mains socket.
- ▶ Electrical equipment should be serviced only by qualified electrical experts, because improper repairs can cause considerable consequential damages..
- ▶ A damaged power cable should only be replaced by the manufacturer, its service agent or similarly qualified persons in order to avoid a hazard.

10.1 Information codes

Following codes are displayed only for information referring to the washing cycle. No measures must be performed.

Code	Message
<i>1:25</i>	The remaining wash cycle time will be 1 hour and 25 minutes
<i>6:30</i>	The remaining wash cycle time including chosen end-time delay will be 6 hours and 30 minutes
<i>End</i>	The washing cycle is finished. The appliance shuts off automatically.
<i>[L]o[-]</i>	The function child lock is activated.
<i>Lac[-]</i>	Door is closed because of high water level, high water temperature or spinning cycle.
<i>bEEP off</i>	The buzzer is deactivated
<i>bEEP on</i>	The buzzer is activated

10.2 Troubleshooting with display code

Problem	Cause	Solution
<i>[Lr FLr</i>	<ul style="list-style-type: none"> • Drainage error, water is not fully drained within 6 minutes. 	<ul style="list-style-type: none"> • Clean pump filter. • Check drain hose installation.
<i>E2</i>	<ul style="list-style-type: none"> • Lock error 	<ul style="list-style-type: none"> • Shut the door properly.
<i>E4</i>	<ul style="list-style-type: none"> • Water level not reached after 8 minutes. • Drain hose is self-syphoning. 	<ul style="list-style-type: none"> • Make sure that tap is fully opened and water pressure is normal. • Check drain hose installation.
<i>E8</i>	<ul style="list-style-type: none"> • Water protective level error. 	<ul style="list-style-type: none"> • Contact the After sales service.

Problem	Cause	Solution
F3	<ul style="list-style-type: none"> Temperature sensor error. 	<ul style="list-style-type: none"> Contact the After sales service.
F4	<ul style="list-style-type: none"> Heating error. 	<ul style="list-style-type: none"> Contact the After sales service.
F7	<ul style="list-style-type: none"> Motor error 	<ul style="list-style-type: none"> Contact the After sales service
FA	<ul style="list-style-type: none"> Water level sensor error. 	<ul style="list-style-type: none"> Contact the After sales service.
FE for FE2 FE3	<ul style="list-style-type: none"> Abnormal communication error. 	<ul style="list-style-type: none"> Contact the After sales service.

10.3 Troubleshooting without display code

Problem	Cause	Solution
Appliance fails to operate.	<ul style="list-style-type: none"> Programme is not yet started. Door is not properly closed. Machine has not been switched on. Power failure. Child lock is activated. 	<ul style="list-style-type: none"> Check programme and start it. Close the door properly. Switch the machine on. Check power supply. Deactivate child lock.
Appliance will not be filled with water.	<ul style="list-style-type: none"> No water. Inlet hose is kinked. Inlet hose filter is blocked. Water pressure is less than 0.03 MPa. Door is not properly closed. Water supply failure. 	<ul style="list-style-type: none"> Check water tap. Check inlet hose. Unblock inlet hose filter. Check water pressure. Close the door properly. Ensure the water supply.
Appliance is draining while being filled.	<ul style="list-style-type: none"> Height of drain hose is below 80 cm. Drain hose end could reach into water. 	<ul style="list-style-type: none"> Make sure that drain hose is properly installed. Make sure the drain hose is not in water.
Drainage failure.	<ul style="list-style-type: none"> Drain hose is blocked. Pump filter is blocked. Drain hose end is higher than 100 cm above floor level. 	<ul style="list-style-type: none"> Unblock drain hose. Clean pump filter. Make sure that drain hose is properly installed.
Strong vibration while spinning.	<ul style="list-style-type: none"> Not all transportation bolts have been removed. Appliance has no solid position. Machine load is not correct. 	<ul style="list-style-type: none"> Remove all transportation bolts. Ensure solid ground and a levelled position Check load weight and balance.
Operation stops before completing wash cycle.	<ul style="list-style-type: none"> Water or electric failure. 	<ul style="list-style-type: none"> Check power and water supply.
Operation stops for a period of time.	<ul style="list-style-type: none"> Appliance displays error code. Problem due to load pattern. Programme performs soaking cycle. 	<ul style="list-style-type: none"> Consider display codes. Reduce or adjust load. Cancel programme and restart.
Excessive foam floats drum and/or detergent drawer.	<ul style="list-style-type: none"> Detergent is not appropriate. Excessive use of detergent. 	<ul style="list-style-type: none"> Check detergent recommendations. Reduce amount of detergent.

Problem	Cause	Solution
Automatic adjustment of washing time.	<ul style="list-style-type: none"> Washing programme duration will be adjusted. 	<ul style="list-style-type: none"> This is normal and doesn't affect functionality.
Spinning fails.	<ul style="list-style-type: none"> Unbalance of laundry. 	<ul style="list-style-type: none"> Check machine load and laundry and run a spinning programme again.
Unsatisfactory washing result.	<ul style="list-style-type: none"> Degree of pollution does not agree with selected programme. Detergent quantity was not sufficient. Maximum load has been exceeded. Laundry was unevenly distributed in the drum. 	<ul style="list-style-type: none"> Select an other programme. Choose the detergent acc. to the degree of pollution and acc. to manufacturer specifications. Reduce loading. Loose the laundry.
Washing powder residues are on the laundry.	<ul style="list-style-type: none"> Insoluble particles of detergent can remain as white spots on the laundry. 	<ul style="list-style-type: none"> Perform extra rinse. Try to brush the points from the dry laundry. Choose an other detergent.
Laundry has grey patches.	<ul style="list-style-type: none"> Caused by fats such as oils, creams or ointments. 	<ul style="list-style-type: none"> Pretreat the laundry with a special cleaner.

i Note: Foam formation

If too much foam is inspected during spin cycle, motor stops and drain pump will be activated for 90 seconds. If that elimination of foam fails up to 3 times, programme ends without spinning.

Should the error messages reappear even after the taken measures, switch off the appliance, disconnect the power supply and contact the customer service.

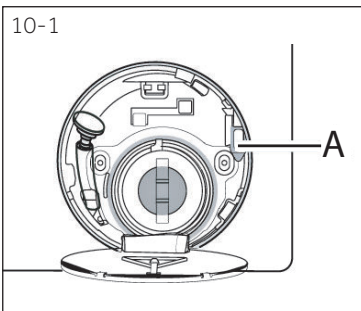

10.4 In case of power failure

The current programme and its setting will be saved. When power supply is restored operation will be resumed.

If a power failure cuts an operating wash programme door opening is mechanically blocked. To get out any laundry water level should not be seen in the glassy porthole of the door - Danger of burns! Water level has to be lowered as described in "Pump filter". Not till then pull lever (A) beneath service flap (Fig. 10-1) until door is unlocked by a gentle click. Afterwards refix all parts.

i Note: Unlock the door

When the washing machine in a safe state (under the water level below the window along a certain distance, barrel temperature below 55 °C, the inner barrel did not turn), may unlock the doors of the machine operation.

11.1 Preparation

- ▶ Take the appliance out of the packaging.
- ▶ Remove all packaging material including polystyrene base, keep them out of childrens reach. While opening the package, water drops may be seen on plastic bag and port-hole. This normal phenomenon results from water tests in the factory.



Note: Packaging disposal

Keep all packaging materials out of children's reach and dispose them in an environmentally friendly manner.

11.2 OPTIONAL: Install noise reduction pads

1. When opening the shrink package, you will find some noise reduction pads. These are used for reducing noise. (Fig. 11-1.1)
2. Lay the washing machine down to its side, porthole pointing upwards, bottom side towards operator (Fig. 11-1.2).
3. Take out the noise reduction pads and remove the double-sided adhesive protective film; paste around the bottom; the noise reduction pads under the w- ashing machine cabinet as shown in Figure 3 (two longer pads in position 1 and 3, two shorter pads in position 2 and 4). Finally set the machine upright again (Fig. 11-1.3).

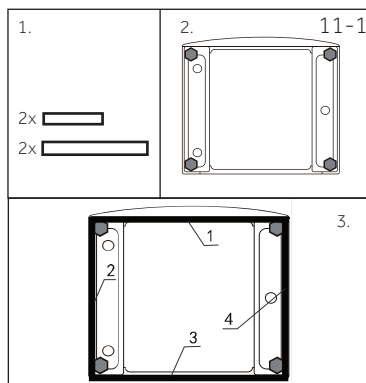

Note: Noise reduction pad

Noise reduction pad is optional, could help to reduce noise, please assemble it or not according to your own demand.

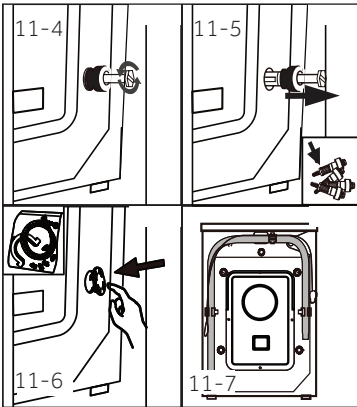

11.3 Dismantle the transportation bolts

The transportation bolts are designed for clamping anti-vibration components inside the appliance during transportation to prevent inner damage.

1. Remove all 4 bolts on the rear side and take out plastic spacers (Fig. 11-4 / Fig. 11-5).
2. Fill left holes with blanking plugs (Fig. 11-6 / Fig. 11-7).



Note: Keep in safe place

Keep the transportation bolts in a safe place for later use. Whenever the appliance is to be moved at first reinstall the bolts.

11.4 Moving the appliance

If the machine is to be moved to a distant location, replace the transportation bolts removed before installation to prevent damage: The assembly takes place in reverse order.

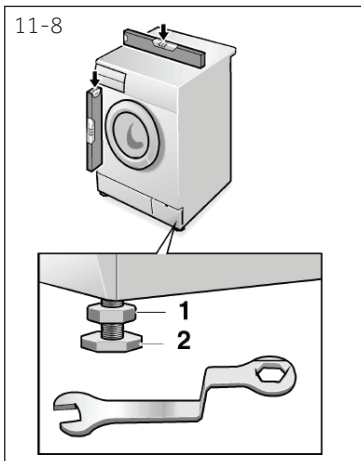

11.5 Aligning the appliance

Adjust all feet (Fig. 11-8) to achieve a complete level position. This will minimize vibrations and thus noise during use. It will also reduce wear and tear. We recommend to use a spirit level for adjustment. Floor should be as stable and flat as possible.

1. Loose the locknut (1) by using a wrench.
2. Adjust the high by turning the foot (2).
3. Tighten lock ut (1) against the housing.

11.6 Drain Water Connection

Fix the water drain hose properly to the piping. The hose has to reach at one point a height between 80 and 100 cm above the appliance bottom line! If possible keep always drain hose fixed to the clip at the appliance back.



WARNING!

- ▶ Use only the supplied hose set for the connection.
- ▶ Never reuse old hose sets!
- ▶ Only connect to cold water supply.
- ▶ Before connection, check whether the water is clean and clear.

Following connections are possible:

11.6.1 Drain hose to sink

- ▶ Hang the drain hose with the U-support over the edge of a sink with adequate size (Fig. 11-9).
- ▶ Protect the U-support sufficiently against slipping.

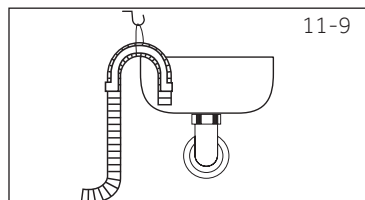

11.6.2 Drain hose to waste water connection

- ▶ The internal diameter of the stand pipe with vent-hole must be minimum 40 mm.
- ▶ Put the drain hose for approx. 80-100 mm in the wastewater pipe.
- ▶ Attach the U-support and secure it sufficiently (Fig. 11-10).

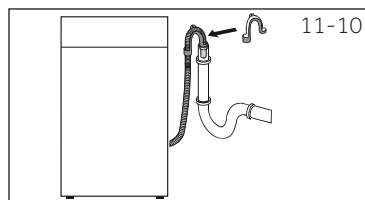

11.6.3 Drain hose to sink connection

- ▶ The junction must lie above the siphon
- ▶ A spigot connection is usually closed by a pad (A). That must be removed to prevent any disfunction (Fig. 11-11).
- ▶ Secure the drain hose with a clamp.

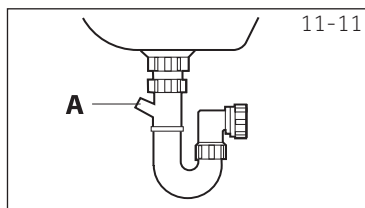

CAUTION!

- ▶ The drain hose should not be submerged in water and should be securely fixed and leak-free. If the drain hose is placed on the ground or if the pipe is at a height of less than 80 cm, the washing machine will continuously drain while being filled (self-siphoning).
- ▶ Drain hose is not to be extended. If necessary contact after sales service.

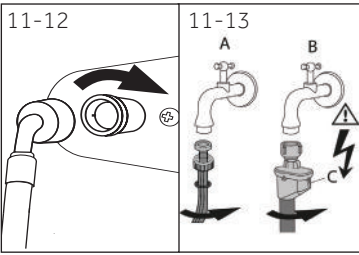

11.7 Fresh Water Connection

Make sure that the gaskets are inserted.

1. Connect the water inlet hose with the angled end to the appliance (Fig. 11-12). Tighten the screw joint by hand.
2. The other end connect to a water tap with a 3/4" thread (Fig. 11-13).

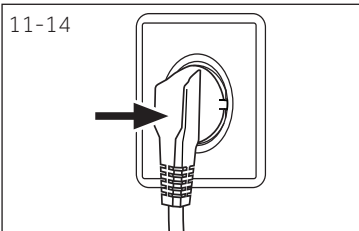

11.8 Electrical Connection

Before each connection check if:

- ▶ power supply, socket and fusing are appropriate to the rating plate.
- ▶ the power socket is earthed and no multi-plug or extension are used.
- ▶ the power plug and socket are strictly according.
- ▶ **Only UK:** The UK plug meets BS1363A standard.

Put the plug into the socket (Fig. 11-14).



WARNING!

- ▶ Ensure always that all connections (power supply, drain and fresh water hose) are firm, dry and leak free!
- ▶ Take care these parts are never to be crushed, kinked, or twisted
- ▶ If the supply cord is damaged, it must be replaced by the service agent (see warranty card) in order to avoid a hazard. .

12.1 Additional technical data

	HWD80-B14959EU1	HWD90-B14959EU1
Voltage in V	220-240 V~/50Hz	
Current in A	10	
Max. power in W	2000	
Water pressure in MPa	0,03-≤P≤1	
Netto weight in kg	65	

12.2 Product dimensions

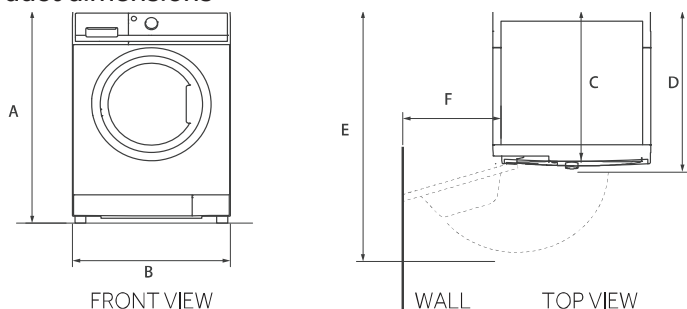

PRODUCT DIMENSIONS	HWD80-B14959EU1	HWD90-B14959EU1
A Overall height of product mm	850	
B Overall width of product mm	595	
C Overall depth of product (To main control board size) mm	497	
D Depth of door open mm	577	
E Minimum door clearance to adjacent wall mm	1085	
F Overall depth of product (Including the thickness of the door) mm	300	

i Hinweis: Exact height

The exact height of your washer is dependent on how far the feet are extended from the base of the machine. The space where you install your washer needs to be at least 40mm wider and 20mm deeper than its dimensions.

12.3 Standards and Directives **CE**

This product meets the requirements of all applicable EC directives with the corresponding harmonised standards, which provide for CE marking.

Hereby, Haier declares that the radio equipment type is in compliance with Directive 2014/53/EU. The full text of the EU declaration of conformity is available at the following internet address: www.haier.com.

We recommend our Haier Customer Service and the use of original spare parts, and the minimum period during which the spare parts for the household washing machine is 10 years.

If you have a problem with your appliance, please first check section TROUBLESHOOTING. If you cannot find a solution there, please contact

- ▶ your local dealer.
- ▶ the Service & Support area at www.haier.com where you can find telephone numbers and FAQs and where you can activate the service claim.

For specific product information, please login to the Haier official website https://www.haier-europe.com/en_GB/technical-assistance/ and search the model you use, click the product to go to the detail page then click "documents" to find the user manual to download it.

You can also find the product information in this page.

Model information is available in the product database at <https://eprel.ec-europa.eu/> by searching for the model identifier reported on the product label.

To contact our Service, ensure that you have the following data available.

The information can be found on the rating plate.

Model _____ Serial No. _____

Also check the Warranty Card supplied with the product in case of warranty. For general business enquiries please find below our addresses in Europe:

European Haier addresses			
Country*	Postal address	Country*	Postal address
Italy	Haier Europe Trading SRL Via De Cristoforis, 12 21100 Verese ITALY	France	Haier France SAS 53 Boulevard Ornano – Pleyad 3 93200 Saint Denis FRANCE
Spain Portugal	Haier Iberia SL Pg. Garcia Faria, 49-51 08019 Barcelona SPAIN	Belgium-FR Belgium-NL Netherlands Luxembourg	Haier Benelux SA Anderlecht Route de Lennik 451 BELGIUM
Germany Austria	Haier Deutschland GmbH Konrad-Zuse-Platz 6 81829 München GERMANY	Poland Czechia Hungary Greece Romania Russia	Haier Poland Sp. zo.o. Al. Jerozolimskie 181B 02-222 Warszawa POLAND
United Kingdom	Haier Appliances UK Co.Ltd. One Crown Square Church Street East Woking, Surrey, GU21 6HR UK		

*For more information please refer to www.haier.com

Model information is available in the product database at <https://eprel.ec.europa.eu/> by searching for the model identifier reported in the field model of the product label affixed on the product; the link to the model in the product database can be found here below for each model identifier: _____



HW80-B14959EU1



W90-B14959EU1

HW80-B14959EU1/ HW90-B14959EU1

Haier